

COMPACT HIGH POWER RELAY

1 POLE - 30A (28VDC)

(For 24V battery automotive applications)

FBR57 Series

■ FEATURES

- High power contact capacity
(carrying current: 40 A/10 minutes, 30 A/1 hour)
 - Suitable for controlling 24 V motors in trucks and other large vehicles
 - High heat resistance and extended operating voltage
 - Contact gap 0.8mm
 - RoHS compliant
- Please see page 6 for more information



■ PARTNUMBER INFORMATION

[Example] FBR57 N D24 - W1 - **
 (a) (b) (c) (d) (e)

(a)	Relay type	FBR57 : FBR57 Series
(b)	Enclosure	N : Plastic sealed type
(c)	Coil rated voltage	D24 : 24 VDC Coil rating table at page 2
(d)	Contact material	W1 : Silver-tin oxide indium Y : Silver-tin oxide
(e)	Special type	To be assigned custom specification

Actual marking does not carry the type name: "FBR"
 E.g.: Ordering code: FBR57ND24-W1 Actual marking: 57ND24-W1

FBR57 SERIES

■ SPECIFICATION

Item	FBR57		
Contact Data	Configuration	1 form C	
	Material	Silver-tin oxide indium (-W1 type) Silver-tin oxide (-Y type)	
	Voltage drop	Max. 100 mV at 1A, 12VDC	
	Contact rating	28VDC, 12A (locked motor load) 28VDC, Inrush 15A, break 2.5A (motor free load)	
	Max. carrying current	40A/10 minutes, 30A/1 hour (25 °C, 100% rated coil voltage)	
	Max. inrush current	70A (reference)	
	Max. switching voltage	28VDC (reference)	
	Max. switching current	12A (reference)	
	Min. switching load *	6 VDC, 1A	
Life	Mechanical	Min. 10 x 10 ⁶ operations	
	Electrical	Min. 100 x 10 ³ operations (locked motor load) Min. 500 x 10 ³ operations (motor free load)	
Coil Data	Operating temperature range	-40 °C to +85 °C (no frost)	
	Storage temperature range	-40 °C to +100 °C (no frost)	
Timing Data	Operate (at nominal voltage)	Max. 10 ms	
	Release (at nominal voltage)	Max. 5 ms	
Insulation	Resistance (initial)	Min. 100MΩ at 500VDC	
	Dielectric withstanding voltage	Open contacts	500VAC, 1 min.
		Between coil and contacts	500VAC, 1 min.
Other	Vibration resistance	Misoperation	10 to 200Hz, acceleration 44m/s ² (4.5G), constant acceleration
		Endurance	10 to 200Hz, acceleration 44m/s ² (4.5G), constant acceleration
	Shock	Misoperation	100m/s ²
		Endurance	1,000m/s ²
	Weight	Approximately 9.4 g	

* Minimum switching loads mentioned above are reference values. Please perform the confirmation test with actual load before production since reference values may vary according to switching frequencies, environmental conditions and expected reliability levels.

Note: Care shall be taken on the heat generated on PC board when maximum carrying current exceeds 10A. Please perform the confirmation test with actual conditions.

■ COIL RATING

Coil Code	Rated Coil Voltage (VDC)	Coil Resistance +/- 10% (Ohm)	Must Operate Voltage (VDC) *	Must Release Voltage (VDC)*
D24	24	384	14.4 (at 20 °C)	1.9 (at 20 °C)
			18 (at 85 °C)	2.4 (at 85 °C)

Note: All values in the table are valid for 20°C and zero contact current, unless otherwise stated.

Note: Please use at rated coil voltage. Please refer to characteristic data and set up adequate voltage in case of use

* Specified operate values are valid for pulse wave voltage.

CHARACTERISTIC DATA

(Characteristic data is not guaranteed value but measured values of samples from production line.)

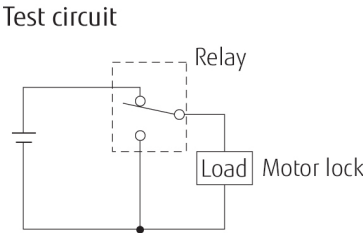
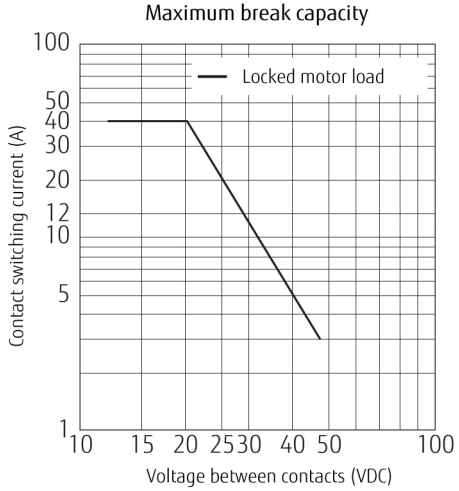

Life test (example)

(1) Motor lock

Test item	Test circuit	Current wave form
12A, 28VDC Motor lock 100,000 operations minimum Contact material: Silver tin oxide indium		

(2) Motor free

Test item	Test circuit	Current wave form
Inrush 15A, Idle 2.5A 28VDC Motor free 500,000 operations minimum Contact material: Silver tin oxide indium		

FBR57 SERIES

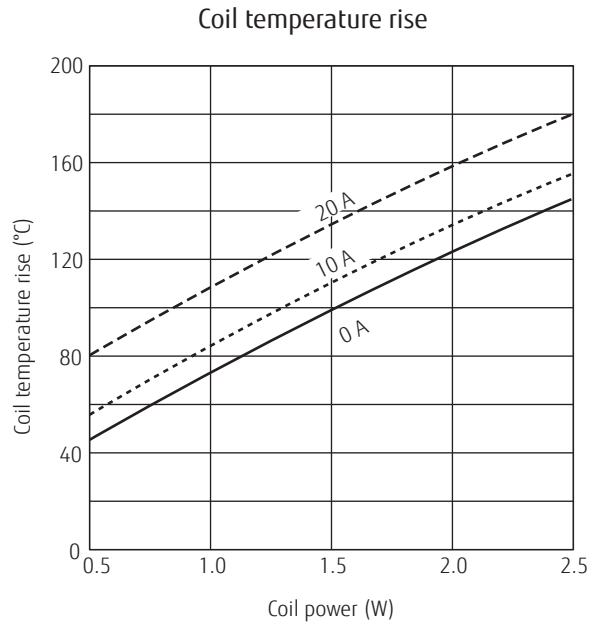
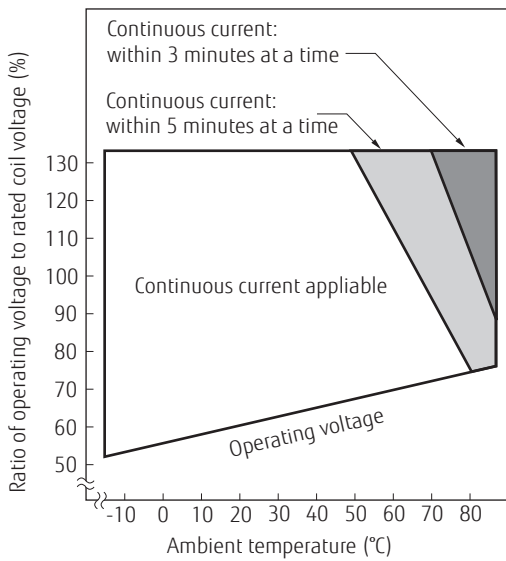

Vibration resistance characteristics

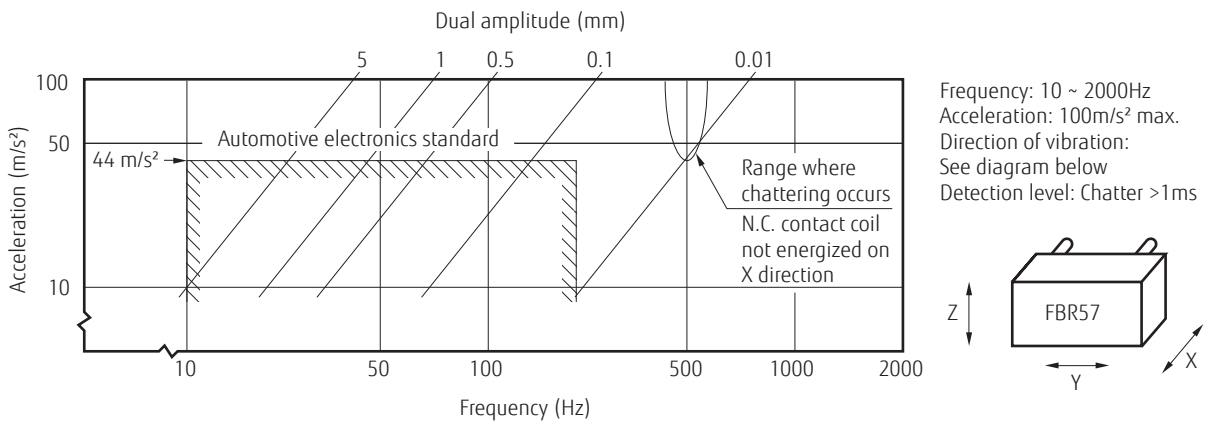

Shock resistance characteristics

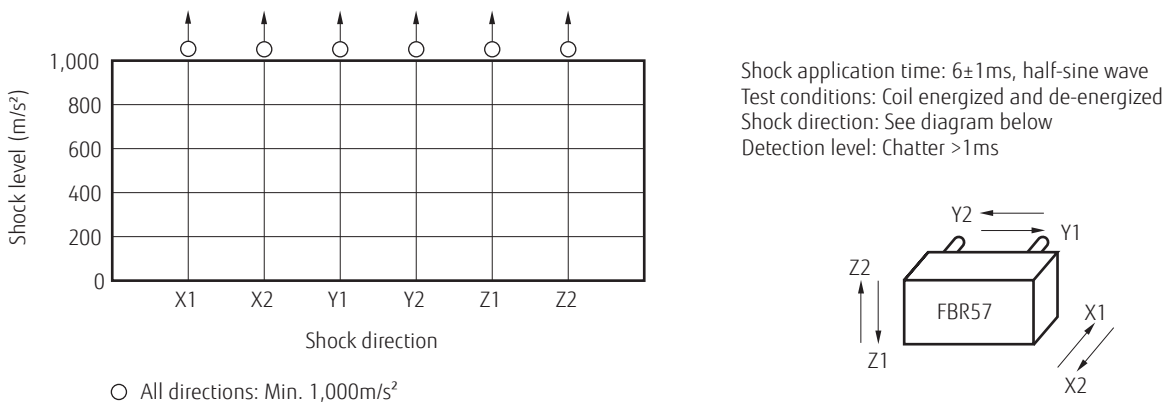

FBR57 SERIES

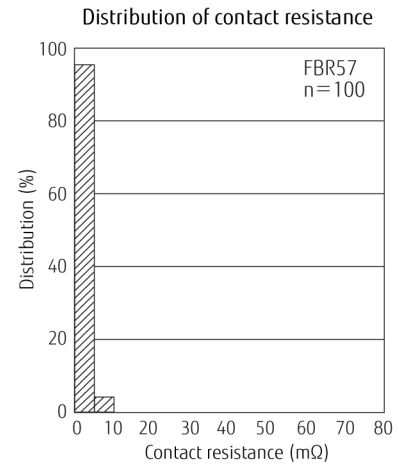
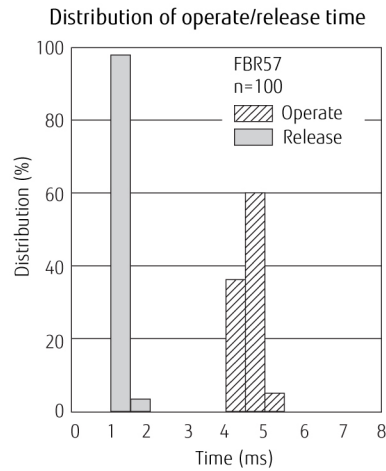
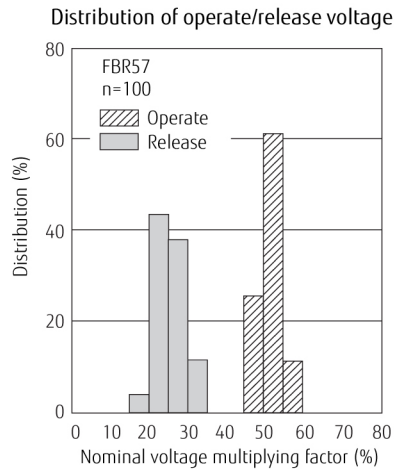

■ DIMENSIONS

● Dimensions

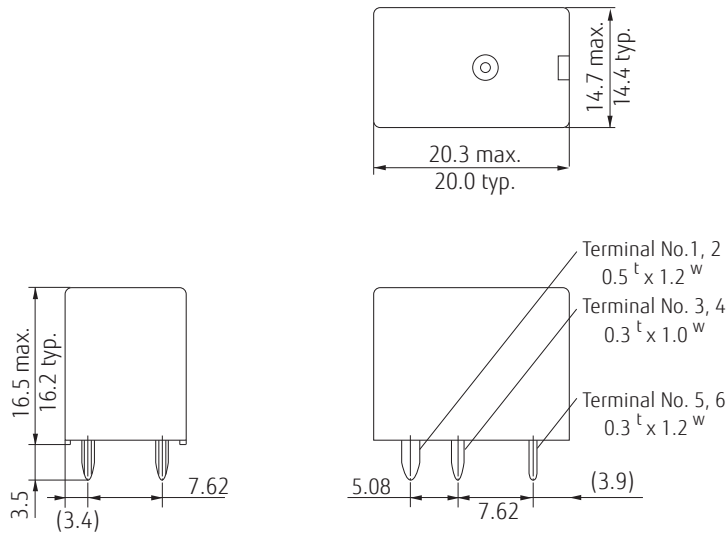

● Schematics (BOTTOM VIEW)

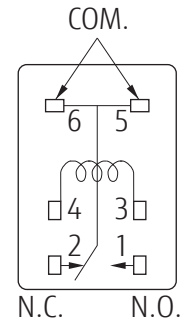

● PC board mounting hole layout (BOTTOM VIEW)

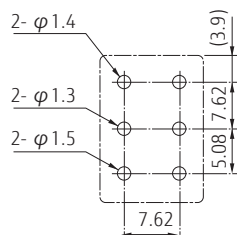

- * Dimensions of the terminals do not include thickness of pre-solder.
- * Tolerance of PC board mounting hole layout : ± 0.1 unless otherwise specified.
- * Dimensions do not include tolerances. Please ask specification in case you need tolerances.

() : Reference Unit: mm

Cautions

- All values mentioned in this datasheet are provided under ideal conditions. Please perform the confirmation test before actual use.
- Reflow soldering is prohibited for standard type.
- Do not use relays in the atmosphere with sulfide gas, chloride gas or nitric oxide. Contact resistance may increase.
- Do not use silicon or silicon-containing product or materials near relays. It may cause contact failure.

RoHS Compliance and Lead Free Information

1. General Information

- All relays produced by Fujitsu Components are compliant with RoHS directive 2011/65/EU including amendments.
- Cadmium as used in electrical contacts is exempted from the RoHS directives. As per Annex III of directive 2011/65/EU.
- All relays are lead-free. Please refer to Lead-Free Status Info for older date codes at: <http://www.fujitsu.com/downloads/MICRO/fcai/relays/lead-free-letter.pdf>
- Lead free solder plating on relay terminals is Sn-3.0Ag-0.5Cu, unless otherwise specified. This material has been verified to be compatible with PbSn assembly process.

2. Recommended Lead Free Solder Condition

- Recommended solder Sn-3.0Ag-0.5Cu.

Flow Solder Condition:

Pre-heating: maximum 120°C
within 90 sec.
Soldering: dip within 5 sec. at
255°C ± 5°C solder bath
Relay must be cooled by air immediately
after soldering

Solder by Soldering Iron:

Soldering Iron 30-60W
Temperature: maximum 350-360°C
Duration: maximum 3 sec.

We highly recommend that you confirm your actual solder conditions

3. Moisture Sensitivity

- Moisture Sensitivity Level standard is not applicable to electromechanical relays, unless otherwise indicated.

4. Tin Whiskers

- Dipped SnAgCu solder is known as presenting a low risk to tin whisker development. No considerable length whisker was found by our in house test.

Fujitsu Components International Headquarter Offices

Japan FUJITSU COMPONENT LIMITED Shinagawa Seaside Park Tower 19F, 12-4, Higashi-shinagawa 4-chome, Shinagawa-ku, Tokyo, 140-0002, Japan Tel: (81-3) 3450-1682 Fax: (81-3) 3474-2385 Email: fcl-contact@cs.jp.fujitsu.com Web: www.fujitsu.com/jp/fcl/	Asia Pacific FUJITSU COMPONENTS ASIA, LTD. 102E Pasir Panjang Road #01-01 Citilink Warehouse Complex Singapore 118529 Tel: (65) 6375-8560 Fax: (65) 6273-3021 Email: fcal@sg.fujitsu.com Web: www.fujitsu.com/sg/products/devices/components	Korea FUJITSU COMPONENTS KOREA LIMITED Alpha Tower #403, 645 Sampyeong-dong, Bundang-gu, Seongnam-si, Gyeonggi-do, 13524 Korea Tel: (82) 31-708-7108 Fax: (82) 31-709-7108 Email: fcal@sg.fujitsu.com www.fujitsu.com/sg/products/devices/components/
North and South America FUJITSU COMPONENTS AMERICA, INC 2290 North First Street, Suite 212 San Jose, CA 95131, USA Tel: (1-408) 745-4900 Fax: (1-408) 745-4970 Email: components@us.fujitsu.com Web: us.fujitsu.com/components	China FUJITSU ELECTRONIC COMPONENTS (SHANGHAI) CO., LTD. Unit 4306, InterContinental Center 100 Yu Tong Road, Shanghai 200070, China Tel: (86-21) 3253 0998 Fax: (86-21) 3253 0997 Email: fcal@sg.fujitsu.com Web: www.fujitsu.com/sg/products/devices/components	
Europe FUJITSU COMPONENTS EUROPE B.V. Diamantlaan 25 2132 WV Hoofddorp Netherlands Tel: (31-23) 5560910 Fax: (31-23) 5560950 Email: info@fceu.fujitsu.com Web: www.fujitsu.com/uk/components	Hong Kong FUJITSU COMPONENTS HONG KONG CO., LTD Unit 2313, Seapower Tower, Concordia Plaza, No.1 Science Museum Road, TST, Kowloon, Hong Kong Tel: (852) 2881-8495 Tex: (852) 2894-9512 Email: fcal@sg.fujitsu.com Web: www.fujitsu.com/sg/products/devices/components/	

©2021 Fujitsu Components Europe B.V. All rights reserved. All trademarks or registered trademarks are the property of their respective owners.

The contents, data and information in this datasheet are provided by Fujitsu Component Ltd. as a service only to its user and only for general information purposes.

The use of the contents, data and information provided in this datasheet is at the users' own risk.

Fujitsu has assembled this datasheet with care and will endeavor to keep the contents, data and information correct, accurate, comprehensive, complete and up to date.

Fujitsu Components Europe B.V. and affiliated companies do however not accept any responsibility or liability on their behalf, nor on behalf of its employees, for any loss or damage, direct, indirect or consequential, with respect to this datasheet, its contents, data, and information and related graphics and the correctness, reliability, accuracy, comprehensiveness, usefulness, availability and completeness thereof.

Nor do Fujitsu Components Europe B.V. and affiliated companies accept on their behalf, nor on behalf of its employees, any responsibility or liability for any representation or warrant of any kind, express or implied, including warranties of any kind for merchantability or fitness for particular use, with respect to these datasheets, its contents, data, information and related graphics and the correctness, reliability, accuracy, comprehensiveness, usefulness, availability and completeness thereof. Rev. May 12, 2021

Mouser Electronics

Authorized Distributor

Click to View Pricing, Inventory, Delivery & Lifecycle Information:

[Fujitsu:](#)

[FBR57ND24-N](#) [FBR57ND24-W](#) [FBR57ND24-W1](#)