

### »» Features

- 10 general purpose Power Relay.
- Contact rating up to 12A 250VAC (DPNO).
- Epoxy sealed type and flux free.
- Quick connect terminal or PCB terminal available.
- Special version of larger contact gap 1.9mm. (IEC 255/VDE 0436) (DPNO Only)
- Optional to be equipped with lamp, diode, flashed contact, and flanged cover.
- Comply with RoHS-Directive 2002/95/EC.



### »» Type List

Terminal style	Contact form	Designation (provided with)	Enclosure style			
			Straight cover	Flanged cover	Sealed type	Sealed type washable
Quick terminal	DPDT	-----	SCL-DPDT	SCL-DPDT-C1	SCL-DPDT-V	SCL-DPDT-S
	DPNO	-----	SCL-DPNO	SCL-DPNO-C1	SCL-DPNO-V	SCL-DPNO-S
	DPDT	Diode	SCL-D-DPDT	SCL-D-DPDT-C1	SCL-D-DPDT-V	SCL-D-DPDT-S
	DPNO	Diode	SCL-D-DPNO	SCL-D-DPNO-C1	SCL-D-DPNO-V	SCL-D-DPNO-S
	DPDT	Lamp	SCL-L-DPDT	SCL-L-DPDT-C1	SCL-L-DPDT-V	SCL-L-DPDT-S
	DPNO	Lamp	SCL-L-DPNO	SCL-L-DPNO-C1	SCL-L-DPNO-V	SCL-L-DPNO-S
PCB terminal	DPDT	-----	SCL-1-DPDT	-----	SCL-1-DPDT-V	SCL-1-DPDT-S
	DPNO	-----	SCL-1-DPNO	-----	SCL-1-DPNO-V	SCL-1-DPNO-S
	DPDT	Diode	SCL-1-D-DPDT	-----	SCL-1-D-DPDT-V	SCL-1-D-DPDT-S
	DPNO	Diode	SCL-1-D-DPNO	-----	SCL-1-D-DPNO-V	SCL-1-D-DPNO-S
	DPDT	Lamp	SCL-1-L-DPDT	-----	SCL-1-L-DPDT-V	SCL-1-L-DPDT-S
	DPNO	Lamp	SCL-1-L-DPNO	-----	SCL-1-L-DPNO-V	SCL-1-L-DPNO-S
	DPDT	Manual	SCL-1-M-DPDT	-----	-----	-----
	DPNO	Manual	SCL-1-M-DPNO	-----	-----	-----

### »» Ordering Information

SCL    -    □    -    □    -    DPDT    -    □    -    □  
 1        2        3        4        5        6

- |   |  |
|---|--|
| 1. SCL    -- Basic series designation<br>2. Blank -- Quick terminal<br>1        -- PCB terminal<br>3. Blank -- Without special features<br>L        -- Provided with pilot light<br>D        -- Diode across coil<br>M        -- Provided with manual operator<br>H        -- 2 mm contact gap (For DPNO and DC coil type only) | 4. DPDT    -- Double pole double throw<br>DPNO    -- Double pole normally open<br>5. Blank    -- Standard type<br>F        -- Class F<br>6. Blank    -- Straight cover<br>C1       -- Flanged cover<br>V        -- Sealed type<br>S        -- Sealed type washable |
|---|--|

## »» Contact Rating

## ◆ Standard Type

Resistive load	10A 240VAC , 10A 28VDC
----------------	------------------------

## ◆ SCL-H Type

Resistive load	15A 240VAC
Max. switching voltage	250VAC
Max. switching current	15A
Max. switching capacity	3600VA

## »» Coil Rating (DC)

## ◆ Standard Type

Rated voltage (V)	Rated current $\pm 10\%$ at 23°C (mA)	Coil resistance $\pm 10\%$ at 23°C ( $\Omega$ )	Max. continuous voltage at 70°C	Pick up voltage(Max) at 23°C	Drop out voltage(Min) at 23°C	Power consumption at rated voltage
6	150	40	110 % of rated voltage	75 % of rated voltage	10 % of rated voltage	approx. 0.9W
9	100	90				
12	75	160				
15	60	250				
24	37	650				
48	19	2600				
60	15	4000				
110	10	11000				
120	11	11000				

## ◆ SCL-H Type

Rated voltage (V)	Rated current $\pm 10\%$ at 23°C (mA)	Coil resistance $\pm 10\%$ at 23°C ( $\Omega$ )	Max. continuous voltage at 70°C	Pick up voltage(Max) at 23°C	Drop out voltage(Min) at 23°C	Power consumption at rated voltage
3	400	7.5	115 % of rated voltage	80 % of rated voltage	10 % of rated voltage	approx. 1.2W
6	200	30				
9	133.3	67.5				
12	100	120				
24	50	480				
48	25	1920				
60	20	3000				
100	12	8330				
110	10.9	10080				
120	10	12000				

### »» Coil Rating (AC)

Rated voltage (V)	Coil resistance $\pm 10\%$ at 23°C ( $\Omega$ )	Max. continuous voltage at 70°C	Pick up voltage(Max) at 23°C	Drop out voltage(Min) at 23°C	Power consumption at rated voltage
12	40	110 % of rated voltage	85 % of rated voltage	30 % of rated voltage	approx. 1.2VA
24	160				
100	3400				
110	3400				
115	3400				
120	3400				
220	13600				
230	13600				
240	13600				

### »» Specification

Contact material	AgSnO alloy	
Contact resistance <sup>(1)</sup>	30 m $\Omega$ Max. ; (-H) 50 m $\Omega$ Max. (1A/6VDC by 4 pipes m $\Omega$ meter)	
Operate time <sup>(1)</sup>	25 ms Max.	
Release time <sup>(1)</sup>	25 ms Max.	
Insulation resistance <sup>(1)</sup>	100 M $\Omega$ Min. (DC 500V)	
Dielectric strength <sup>(1)</sup>	Between open contact	: AC 1000V , 50/60Hz 1 min.
	Between contact and coil	: AC 1500V , 50/60Hz 1 min.
	Between contact circuits	: AC 1500V , 50/60Hz 1 min.
Vibration resistance	Operating extremes	10~55Hz , amplitude 1.0 mm
	Damage limits	10~55Hz , amplitude 1.0 mm
Shock resistance	Operating extremes	20G ; (-H) 10G
	Damage limits	100G ; (-H) 200G
Life expectancy	Mechanical	10,000,000 operations ; (-H) 3,000,000 ops. (frequency 18,000 operations/hr)
	Electrical	100,000 operations (frequency 1,800 operations/hr) [(-H)1,200 ops/hr]
Operating ambient temperature	-25~+70°C (no freezing)	
Weight	Approx. 35 g	

Note : (1) initial value

### »» Safety Approval

#### ◆ Standard Type

Certified	UL / CUL	CSA	TUV	FIMKO
File No.	E88991	1474290	R50055516	24561

◆ SCL-H Type

Certified	UL / CUL	TUV
File No.	E88991	R50055516

»» Safety Approval Rating

◆ Standard Type

UL / CUL	CSA	TUV	FIMKO
10A 277VAC/28VDC	10A 277VAC	10A 250VAC	10A 250VAC (DPDT)
15A 125VAC	10A 28VDC	10A 30VDC	15A 250VAC(DPNO)
1/3HP 7.5FLA 125VAC	1/2HP 7.5FLA 125VAC		
1/2HP 5.0FLA 250VAC	1/3HP 5.0FLA 240VAC		
1/3HP 3.0FLA 277VAC	15A 240VAC (DPNO ONLY)		
15A 240VAC (DPNO ONLY)			

◆ SCL-H Type

UL / CUL	TUV
16A 277VAC 1/2HP 250VAC	15A 250VAC

»» Outline Dimensions

◆ SCL (C1)

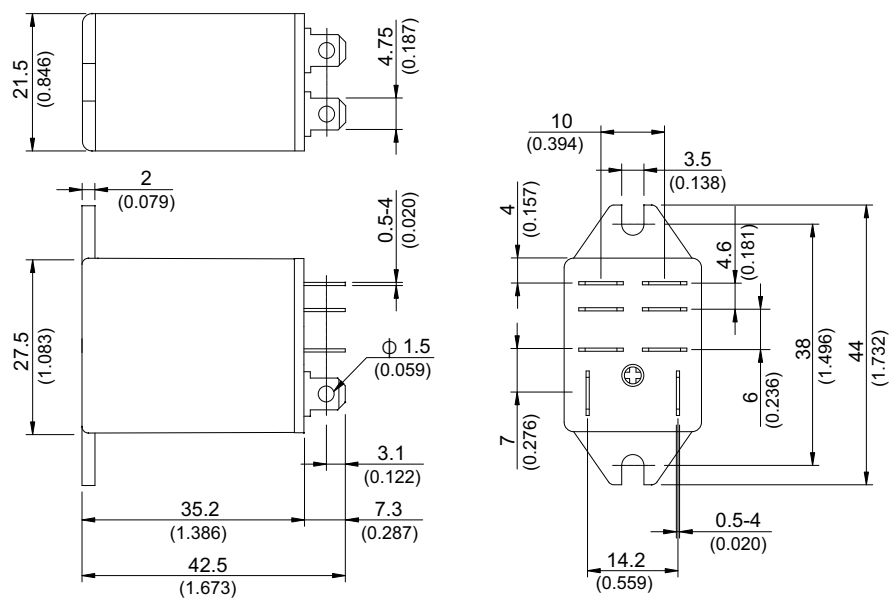

◆ SCL

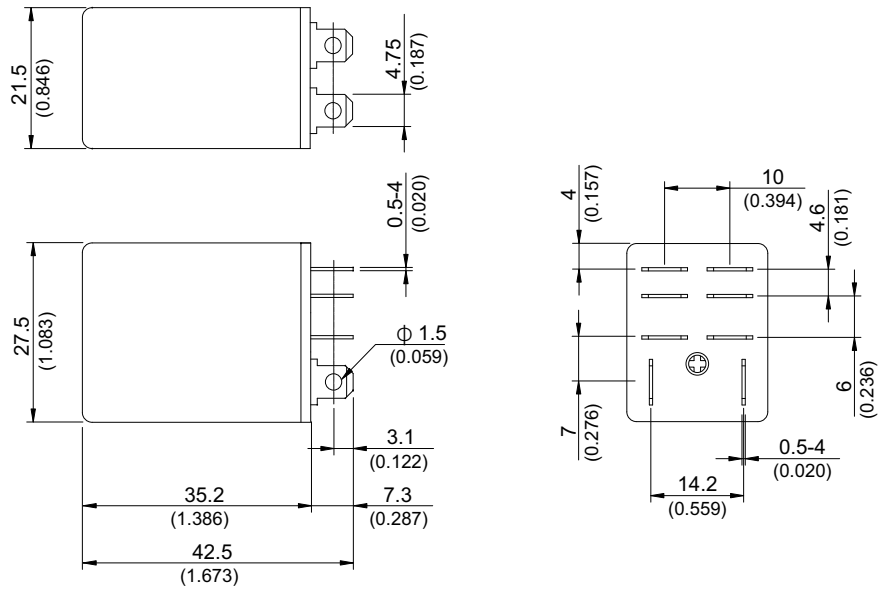

◆ SCL-1

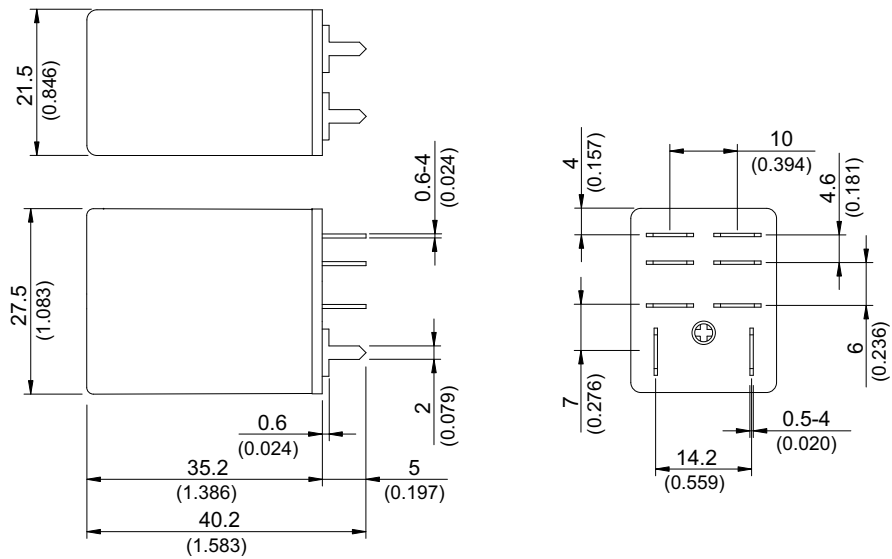

»» Wiring Diagram  
BOTTOM VIEW

DPDT

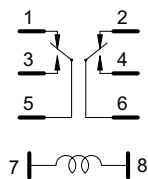

DPNO

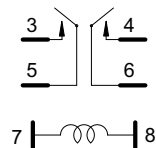

### PC Board Layout BOTTOM VIEW

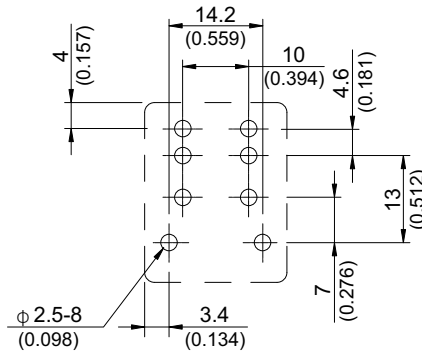

### Designation(Provided with) BOTTOM VIEW

Lamp

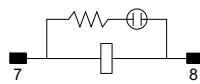

(100~240VAC)

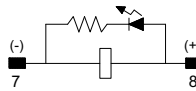

(6~48VDC)

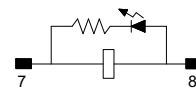

(6~48VAC)

Diode

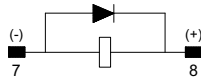

### Engineering Data

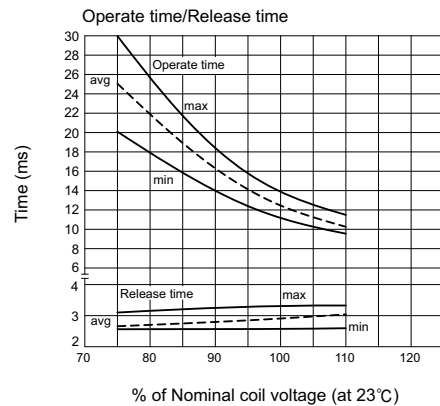
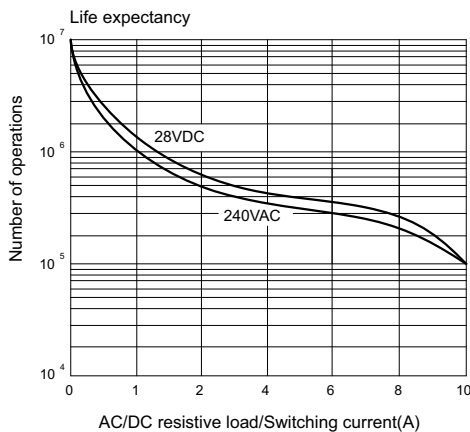
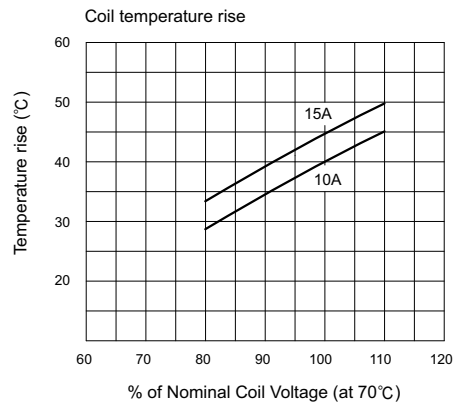
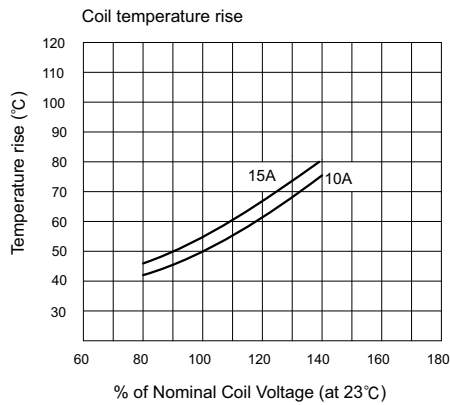

# Mouser Electronics

Authorized Distributor

Click to View Pricing, Inventory, Delivery & Lifecycle Information:

## Song Chuan:

[SCL-DPDT-120VAC](#) [SCL-DPDT-24VDC](#) [SCL-DPDT-C1 240 Vac](#) [SCL-I-DPDT-12VDC](#) [SCL-DPDT-C1 12 Vdc](#) [SCL-1-DPDT-12VDC](#) [SCL-LM-DPDT-230VAC](#) [SCL-DPDT-C1-120VAC](#) [SCL-DPDT-24VAC](#) [SCL-DPDT-C1 120 Vac](#) [SCL-DPDT-12VDC](#) [SCL-DPDT-C1 24 Vdc](#) [SCL-1-DPDT-24VDC](#) [SCL-DPDT-S-24VDC](#) [SCL-LM-DPDT-24VAC](#) [SCL-1-DPDT-110 VDC](#) [SCL-1-DPDT-120VAC](#) [SCL-1-DPNO-24VAC](#) [SCL-1-DPDT-F-120VAC](#) [SCL-1-DPDT-S-24VDC](#) [SCL-1-DPDT-120VDC](#) [SCL-1-DPDT-24VAC](#) [SCL-1-DPDT-220VAC](#) [SCL-1-DPDT-240VAC](#) [SCL-1-DPDT-S-24 VAC](#) [SCL-1-DPDT-S-12VDC](#)