

Solid State Relay G3MC

Compact, Low-cost Fail-safe SSR that Switches up to 2 Amps

- Unlike conventional solid-state devices, Omron's new fail-safe technology eliminates the need for external fuse or safety circuitry in many applications.
- Smaller footprint (approximately 20% smaller than G3MB) is ideal for close PCB mounting applications.
- Built in snubber circuit.
- VDE versions available.

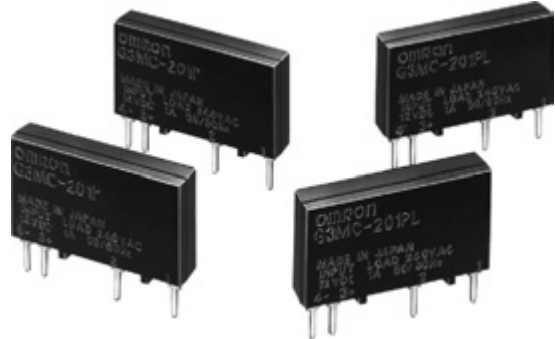

Ordering Information

To Order: Select the part number and add the desired coil voltage rating, (e.g., G3MC-101P-DC12).

Isolation	Zero-cross function	Built-in snubber circuit	Rated output load	Rated input voltage	Model	
Phototriac	Yes	Yes	1 A at 100 to 120 VAC (75 to 132 VAC)	5 VDC	G3MC-101P	
				12 VDC		
				24 VDC		
	No				5 VDC	G3MC-101PL
					12 VDC	
					24 VDC	
	Yes	No	2 A at 100 to 120 VAC (75 to 132 VAC)	5 VDC	G3MC-102P	
				12 VDC		
				24 VDC		
	No				5 VDC	G3MC-102PL
					12 VDC	
					24 VDC	
	Yes	Yes	1 A at 100 to 240 VAC (75 to 264 VAC)	5 VDC	G3MC-201P	
				12 VDC		
				24 VDC		
	No				5 VDC	G3MC-201PL
12 VDC						
24 VDC						
Yes	No	2 A at 100 to 240 VAC (75 to 264 VAC)	5 VDC	G3MC-202P		
			12 VDC			
			24 VDC			
No				5 VDC	G3MC-202PL	
				12 VDC		
				24 VDC		

Note: VDE versions available. Contact your local Omron representative

Specifications

■ RATINGS (AMBIENT TEMPERATURE 25°C)

Input

Rated voltage	Operating voltage	Impedance	Voltage levels	
			Must operate voltage	Must dropout voltage
5 VDC	4 to 6 VDC	300Ω ±20%	4 VDC max.	1 VDC min.
12 VDC	9.6 to 14.4 VDC	800Ω ±20%	9.6 VDC max.	
24 VDC	19.2 to 28.8 VDC	1.6kΩ ±20%	19.2 VDC max.	

Note: Each model has 5-VDC, 12-VDC, and 24-VDC input versions.

Output

Part number	Applicable load			
	Rated load voltage	Load voltage range	Load current	Surge current
G3MC-101P(L)	100 to 120 VAC	75 to 132 VAC	0.1 to 1 A	8 A (60 Hz, 1 cycle)
G3MC-201P(L)	100 to 240 VAC	75 to 264 VAC		
G3MC-102P(L)	100 to 120 VAC	75 to 132 VAC	0.1 to 2 A	30 A (60 Hz, 1 cycle)
G3MC-202P(L)	100 to 240 VAC	75 to 264 VAC		

■ CHARACTERISTICS

Item	G3MC-101P / G3MC-102P	G3MC-101PL / G3MC-102PL	G3MC-201P / G3MC-202P	G3MC-201PL / G3MC-202PL
Operate time	1/2 of load power source cycle + 1 ms	1 ms max.	1/2 of load power source cycle + 1 ms	1 ms max.
Release time	1/2 of load power source cycle + 1 ms)			
Output ON voltage drop	1.6 V (RMS) max.			
Leakage current	1 mA max. (at 100 VAC)		1.5 mA max. (at 200 VAC)	
Insulation resistance	1,000 MΩ min. (at 500 VDC)			
Dielectric strength	2,500 VAC, 50/60 Hz for 1 min			
Vibration resistance	Malfunction: 10 to 55 Hz, 0.75-mm double amplitude			
Shock resistance	Malfunction: 1,000 m/s ² (approx. 100G)			
Ambient temperature	Operating: -30°C to 80°C (with no icing or condensation) Storage: -30°C to 100°C (with no icing or condensation)			
Approved standards	UL508 File No. E64562, CSA C22.2 (No. 14, No. 950) File No. LR35535, EN60950 File No. 5925UG			
Ambient humidity	Operating: 45% to 85%			
Weight	Approx. 2.5 g			

Engineering Data

■ G3MC-101P(L), G3MC-201P(L)

Load Current vs. Ambient Temperature Characteristics

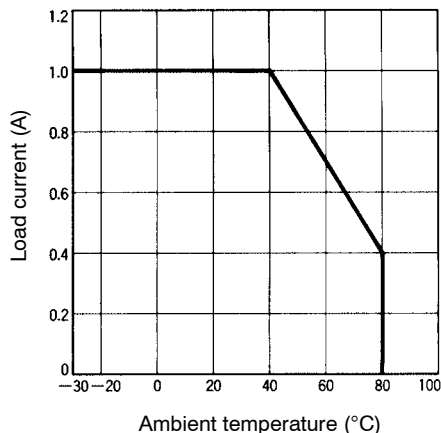

Inrush Current Resistivity

Non-repetitive (Keep the inrush current to half the rated value if it occurs repeatedly.)

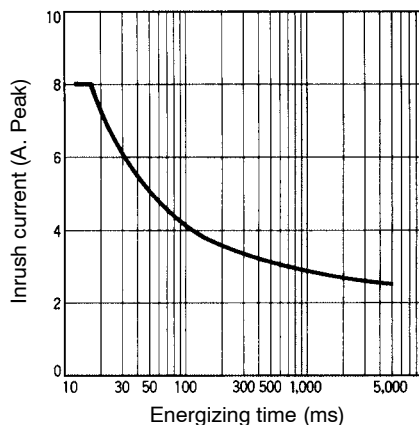

■ G3MC-102P(L), G3MC-202P(L)

Load Current vs. Ambient Temperature Characteristics

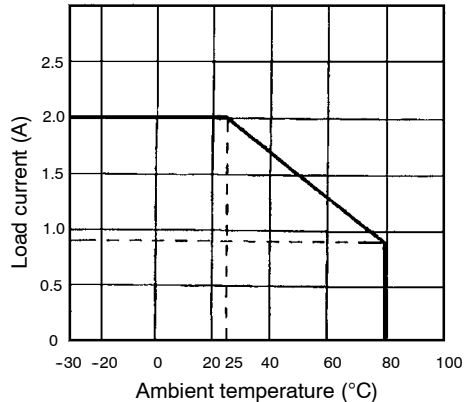

Inrush Current Resistivity

Non-repetitive (Keep the inrush current to half the rated value if it occurs repeatedly.)

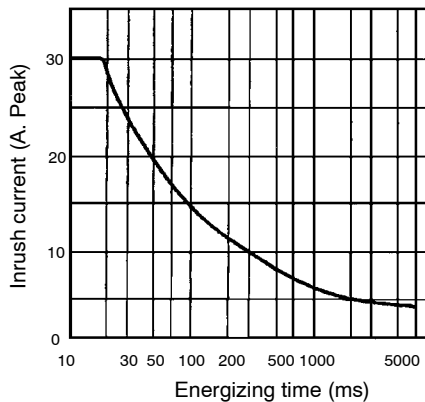

Dimensions

Unit: mm (inch)

**G3MC-101P
G3MC-101PL
G3MC-201P
G3MC-201PL**

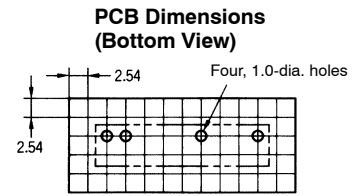
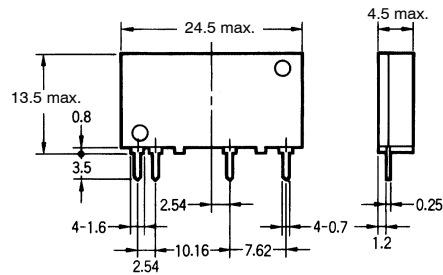
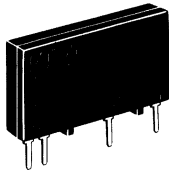

Terminal Arrangement (Bottom View)

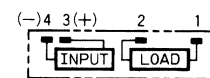

**G3MC-102P
G3MC-102PL
G3MC-202P
G3MC-202PL**

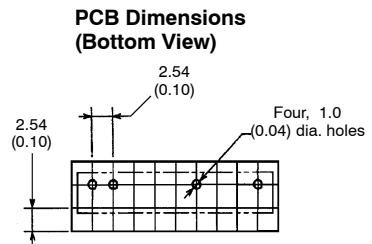
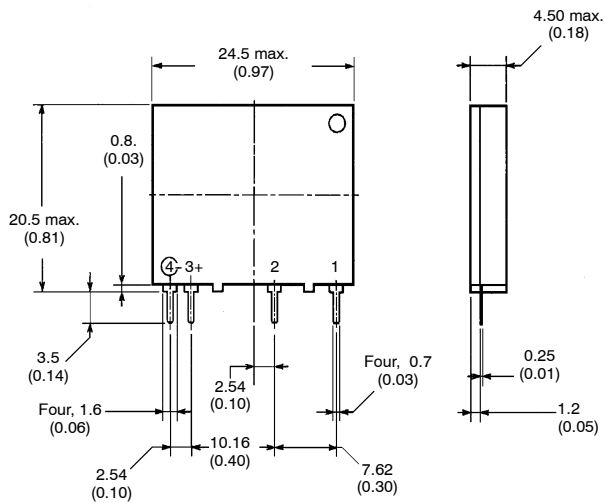
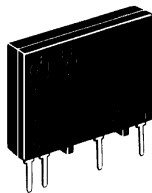

Terminal Arrangement (Bottom View)

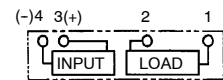

■ APPROVALS

UL (File No. E64562)/CSA (File No. LR35535)

Model	Input voltage	Output ratings
G3MC-101P(L)	5, 12, 24 VDC	120 VAC, 1 A general, 0.6 A FLA/3.6 A RLA, 120 VAC
G3MC-201P(L)		240 VAC, 1 A general, 0.6 A FLA/3.6 A RLA, 240 VAC
G3MC-102P(L)		120 VAC, 2 A general, 1.2 A FLA/7.2 A RLA, 120 VAC
G3MC-202P(L)		240 VAC, 2 A general, 1.2 A FLA/7.2 A RLA, 240 VAC

Precautions

General Precautions

Be sure to turn off power to the SSR before wiring the SSR, otherwise an electric shock may be received.

Do not touch the terminals of the SSR while power is being supplied to the SSR. The terminals are charged with the power, and an electric shock may be received by touching the terminals.

The built-in capacitor may have residual voltage after the SSR is turned off. Be sure to discharge the residual voltage before touching the terminals of the SSR, otherwise an electric shock may be received.

Mounting

1. Make sure that no excessive voltage or current is imposed on or flows to the input or output circuit of the SSR, otherwise the SSR may malfunction or burn.
2. Solder the terminals of the SSR properly under the required soldering conditions. The SSR may be abnormally heated and burn if power is supplied to the terminals soldered incorrectly.
3. Do not short-circuit the load of the SSR while power is supplied to the SSR. Do not short-circuit the power supply through the SSR. The SSR may be damaged, malfunction, or burn if the load or power supply is short-circuited.

Correct Use

The terminals of the SSR are highly heat-conductive. Each terminal must be soldered within 10 s at 260°C or within 5 s at 350°C.

The SSR is of a thin-profile construction. To maintain the vibration resistance of the SSR, make sure that the space between the SSR and PCB is 0.1 mm maximum. Lifting of the PCB can be prevented by setting the hole diameter of the PCBs on both sides slightly smaller than the actual terminal dimension.

Select the model without the zero-cross function when using the Unit for phase control output.

The casing works as a heat sink. When mounting two or more Units closely, make sure that the Units are properly ventilated by taking ambient temperature rises into consideration. If Units are closely mounted and used in places with no ventilation, the load current of each Unit must be 1/2 of the rated load current.

Fusing Characteristics

The G3MC has a function that forces an open mode failure when an overcurrent exceeds the rated value. The fusing characteristics of

the G3MC, however, are not the same as those of a general-use glass fuse. Machines that use the G3MC must be provided with a safety device, such as a fuse or breaker, and ON-OFF tests or short-circuit tests must be implemented to confirm the following items and detailed influences. Users must determine test conditions and implement tests on reliability as required by the machine.

1. Life test under continuous electric current
2. On-off cycle test
3. Influence by ambient temperature
4. Influence by power source frequency
5. Influence by power source voltage fluctuation

Note: Contact your local OMRON sales office for more detailed information.

Protective Element

No overvoltage absorption element is built in. Therefore, if the G3MC is connected to an inductive load, be sure to connect the overvoltage absorption element.

G3MC-□□□PL (without Zero cross function)

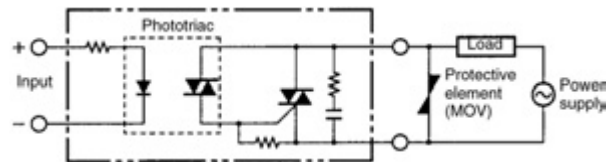

G3MC-□□□P (with Zero cross function)

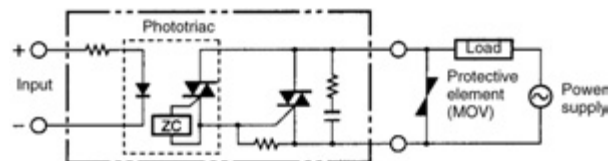

NOTE: DIMENSIONS SHOWN ARE IN MILLIMETERS. To convert millimeters to inches divide by 25.4.

ALL DIMENSIONS SHOWN ARE IN MILLIMETERS. To convert millimeters into inches, divide by 25.4



OMRON ELECTRONICS LLC
One Commerce Drive
Schaumburg, IL 60173
847-882-2288

OMRON CANADA, INC.
885 Milner Avenue
Toronto, Ontario M1B 5V8
416-286-6465

OMRON ON-LINE
Global - <http://www.omron.com>
USA - <http://www.omron.com/oei>
Canada - <http://www.omron.ca>